

SMPTE ST2110 & NMOS IS-08: Audio Transport and Routing

- Andreas Hildebrand –
RAVENNA Technology Evangelist
ALC NetworX, Munich

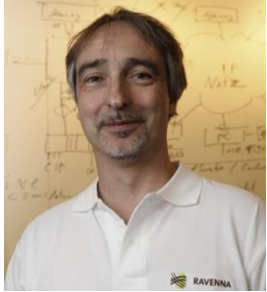

Andreas Hildebrand, RAVENNA Technology Evangelist

- more than 25 years in the professional audio / broadcasting industry
- graduate diploma in computer science
- R&D, project & product management experience
- member of AES67 TG and ST2110 DG



ALC NetworkX GmbH, Munich / Germany

- established 2008
- R&D center
- developing & promoting RAVENNA
- Partnerships with > 40 manufacturers



RAVENNA

- IP media networking technology
- designed to meet requirements of professional audio / broadcasting applications
- open technology approach, license-free
- fully AES67-compliant (*built-in*)



SMPTE 2110 - Professional Media over Managed IP Networks

- Defines transport and synchronization of elementary essence streams (video, audio, ancillary data)
- Primarily targeting at live production applications
- References / builds on existing standards:
 - Timing: SMPTE 2059 (SMPTE PTP Profile)
 - Video: RFC 4175 (RTP Payload Format for Uncompressed Video)
 - Audio: AES67 & RAVENNA
 - Ancillary data: RFC 8331 (RTP Payload for SMPTE ST 291-1 Ancillary Data)

SMPTE 2110

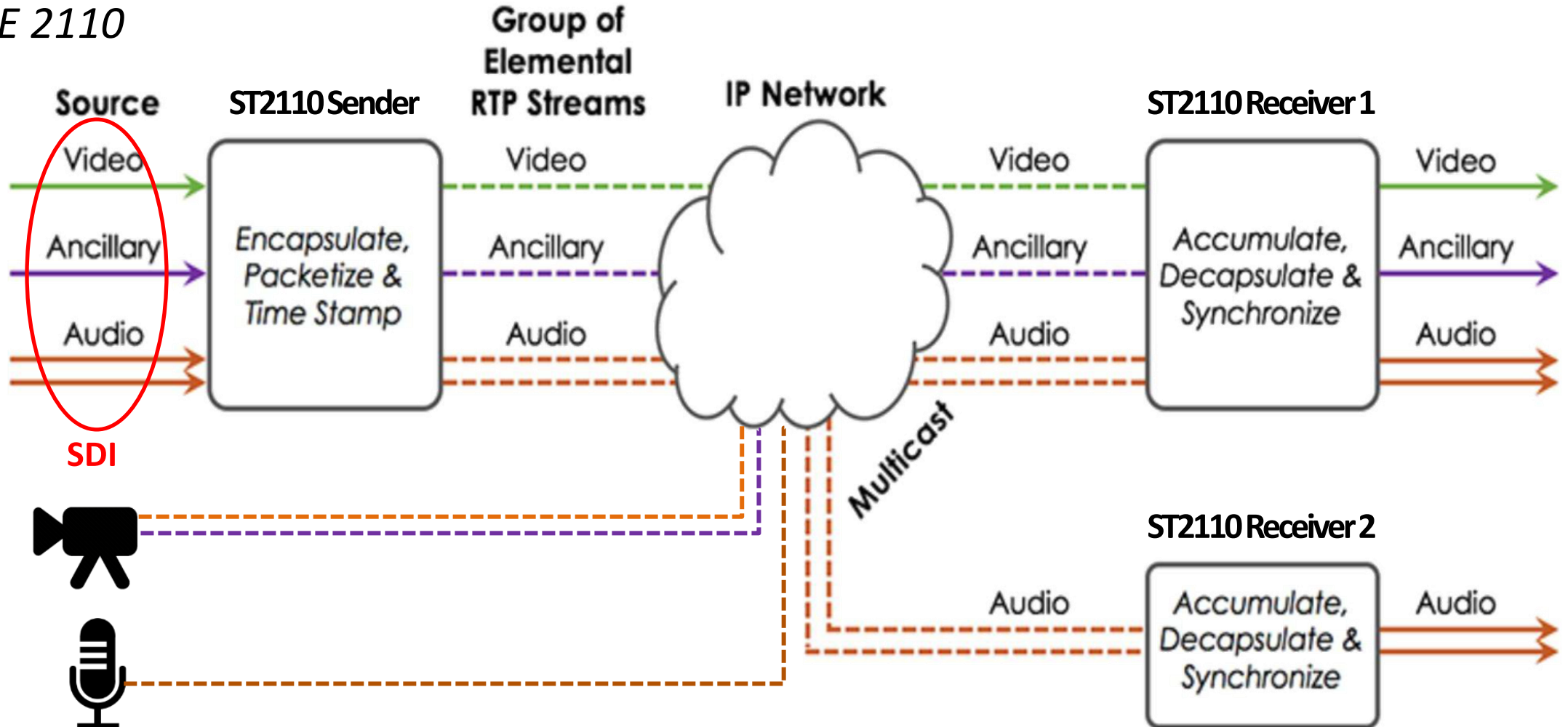

SMPTE 2110 - Professional Media over Managed IP Networks

Document structure:

- 2110-10: System Timing & Definitions
 - defines transport layer and synchronization (SMPTE2059, clocks, RTP, SDP etc.)
- 2110-20: Uncompressed Active Video
 - defines payload format for raw video (RFC4175, RTP, SDP, constraints)
- 2110-21: Traffic Shaping and Delivery Timing for Uncompressed Active Video
 - defines timing model for senders and receivers (traffic shaping requirements)

SMPTE 2110 - Professional Media over Managed IP Networks

Document structure:

- 2110-30: PCM Digital Audio
 - defines payload format for linear audio (AES67, constraints)
- 2110-31: AES3 Transparent Transport
 - defines payload format for non-linear audio (RAVENNA AM824)
- 2110-40: Transport of SMPTE Ancillary Data
 - defines RTP payload format for SDI ancillary data (new IETF draft)

SMPTE 2110 - Professional Media over Managed IP Networks

Document structure (audio):

- 2110-**10**: System Timing & Definitions
 - defines transport layer and synchronization (SMPTE2059, clocks, RTP, SDP etc.)
- 2110-**30**: PCM Digital Audio
 - defines payload format for linear audio (AES67, constraints)
- 2110-**31**: AES3 Transparent Transport
 - defines payload format for non-linear audio (RAVENNA AM824)

SMPTE 2110 - Professional Media over Managed IP Networks

Document structure (linear PCM audio):

- 2110-**10**: System Timing & Definitions
 - defines transport layer and synchronization (SMPTE2059, clocks, RTP, SDP etc.)
- 2110-**30**: PCM Digital Audio
 - defines payload format for linear audio (AES67, constraints)

AES67



AES67

**AES67-~~2013~~²⁰¹⁸ Standard for
Audio Applications of Networks:
*High-performance Streaming Audio-
over-IP Interoperability***

published on September, 11th, 2013

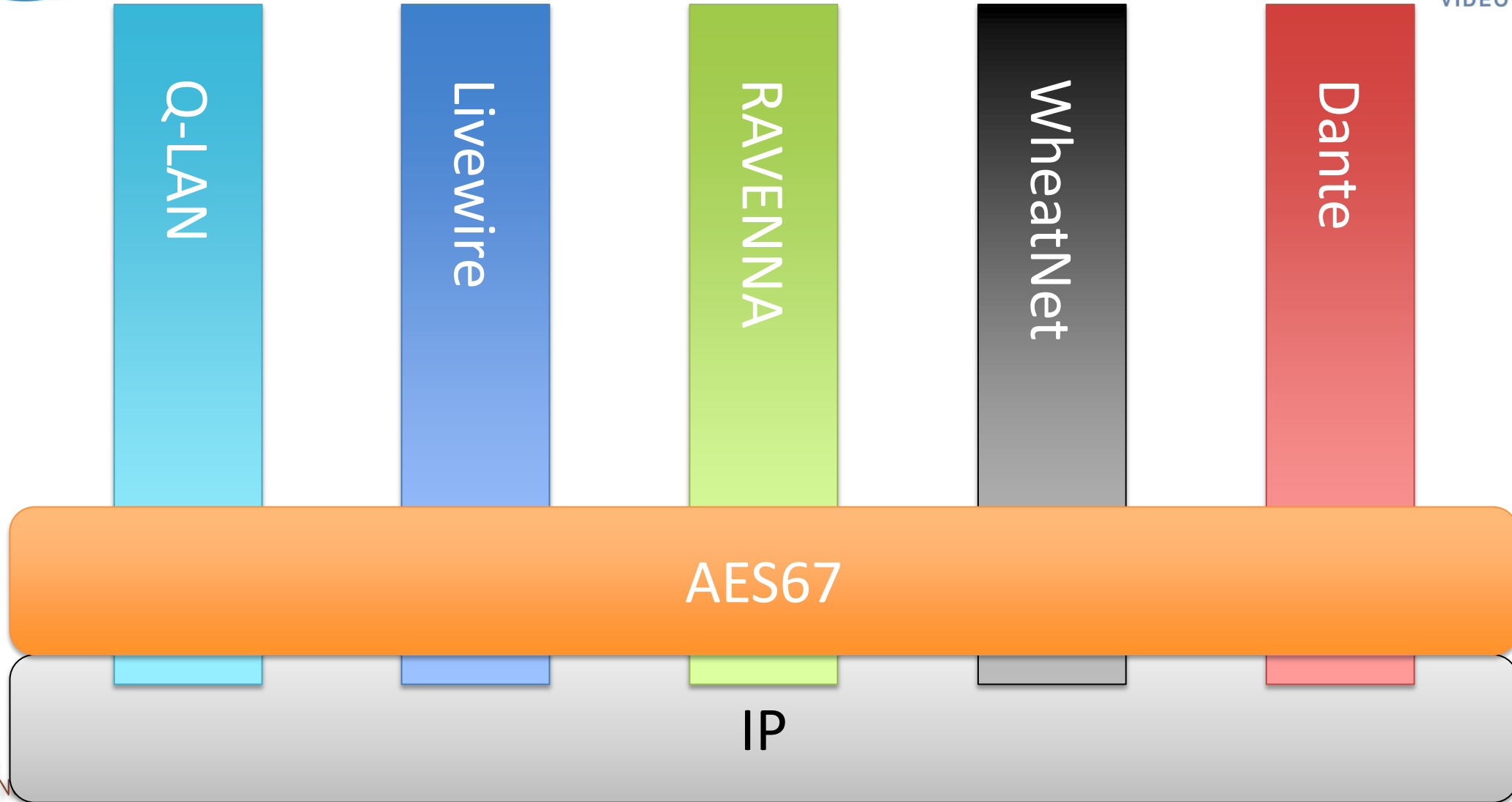

AES67 technology components

Discovery	Not specified (NMOS IS-04/05)
Connection Management	SIP (unicast), IGMP (multicast)
Session Description	SDP (RFC4566, RFC7273)
Encoding	L16/L24, 1..8 ch, 48 samples
QoS	Differentiated Services (DiffServ w/ 3 CoS)
Transport	RTP / UDP / IP, unicast & multicast
Media Clock	48 kHz
Synchronisation	IEEE 1588-2008 (PTPv2)

SMPTE 2110 - Professional Media over Managed IP Networks

Document structure:

- 2110-10: System Timing & Definitions
 - defines transport layer and synchronization (SMPTE2059, clocks, RTP, SDP etc.)
- 2110-30: PCM Digital Audio
 - defines payload format for linear audio (AES67, constraints)

AES67
Constraints!

⇒ AIMS WP on
AES67 / ST2110 Commonalities & Constraints

SMPTE 2110 - Professional Media over Managed IP Networks

Constraints of 2110-10 & -30 w/ respect to AES67

- 6 conformance levels (packet setup):

SMPTE 2110 - Professional Media over Managed IP Networks

Constraints of 2110-10 & -30 w/ respect to AES67

- 6 conformance levels (packet setup):

Level	Supported by the Receiver
A (mandatory)	Reception of 48 kHz streams with 1 to 8 audio channels at packet times of 1 ms

AES67 compliant

SMPTE 2110 - Professional Media over Managed IP Networks

Constraints of 2110-10 & -30 w/ respect to AES67

- 6 conformance levels (packet setup):

Level	Supported by the Receiver
A (mandatory)	Reception of 48 kHz streams with 1 to 8 audio channels at packet times of 1 ms
B	Level A + 1 to 8 channels at packet times of 125 μ s
C	Level A + 1 to 64 channels at packet times of 125 μ s

AES67 compliant

SMPTE 2110 - Professional Media over Managed IP Networks

Constraints of 2110-10 & -30 w/ respect to AES67

- 6 conformance levels (packet setup):

Level	Supported by the Receiver
AX	Level A (\Rightarrow 48 kHz) + Reception of 96 kHz streams with 1 to 4 audio channels at packet times of 1 ms
BX	Level B + AX + 1 to 8 channels at packet times of 125 μ s
CX	Level C + AX + 1 to 32 channels at packet times of 125 μ s

96 kHz

SMPTTE 2110 - Professional Media over Managed IP Networks

What else is required for a working system?

⇒ Establishing connections!

- Not covered by SMPTTE 2110



- AMWA: Advanced Media Workflow Association
- NMOS: “A growing family of specifications [...] which are complementary to and co-exist with industry specifications like ST2110 and AES67”

AMWA NMOS - Networked Media Open Specifications

NMOS specifications:

- IS-04: Discovery & Registration
 - enumeration and registration of available system resources
- IS-05: Connection Management
 - connecting receivers to available streams
- IS-06: Network Control
 - controlling network resources (configuring routing tables)

AMWA NMOS - Networked Media Open Specifications

NMOS specifications:

- IS-07: Event & Tally Specification
 - communicate current states and state changes
- IS-08: Audio Channel Mapping
 - how to match flow channels with inputs / outputs
- BCP-002-01: Grouping of NMOS Resources
 - identifying which flows are related to each other
- ... more in the works...

AMWA NMOS - Networked Media Open Specifications

Key elements

AMWA NMOS - Networked Media Open Specifications

Identity

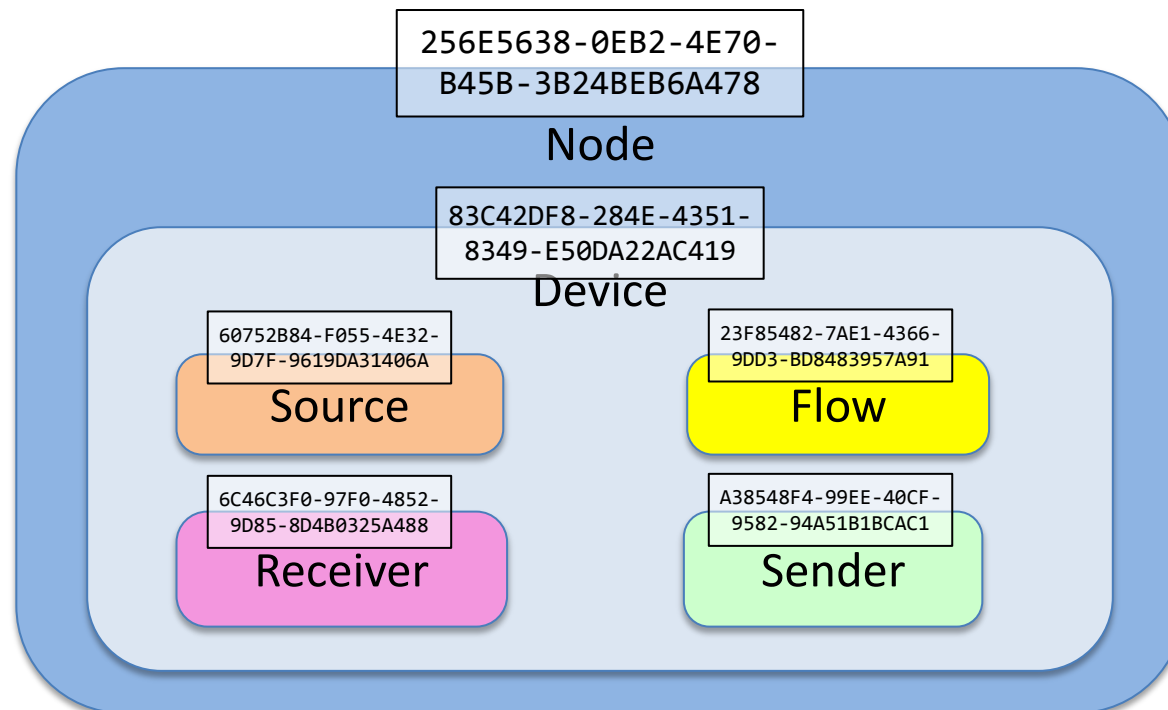

AMWA NMOS - Networked Media Open Specifications

IS-04

Discovery & Registration

Ensure that parts of a networked media system can find each other

AMWA NMOS - Networked Media Open Specifications

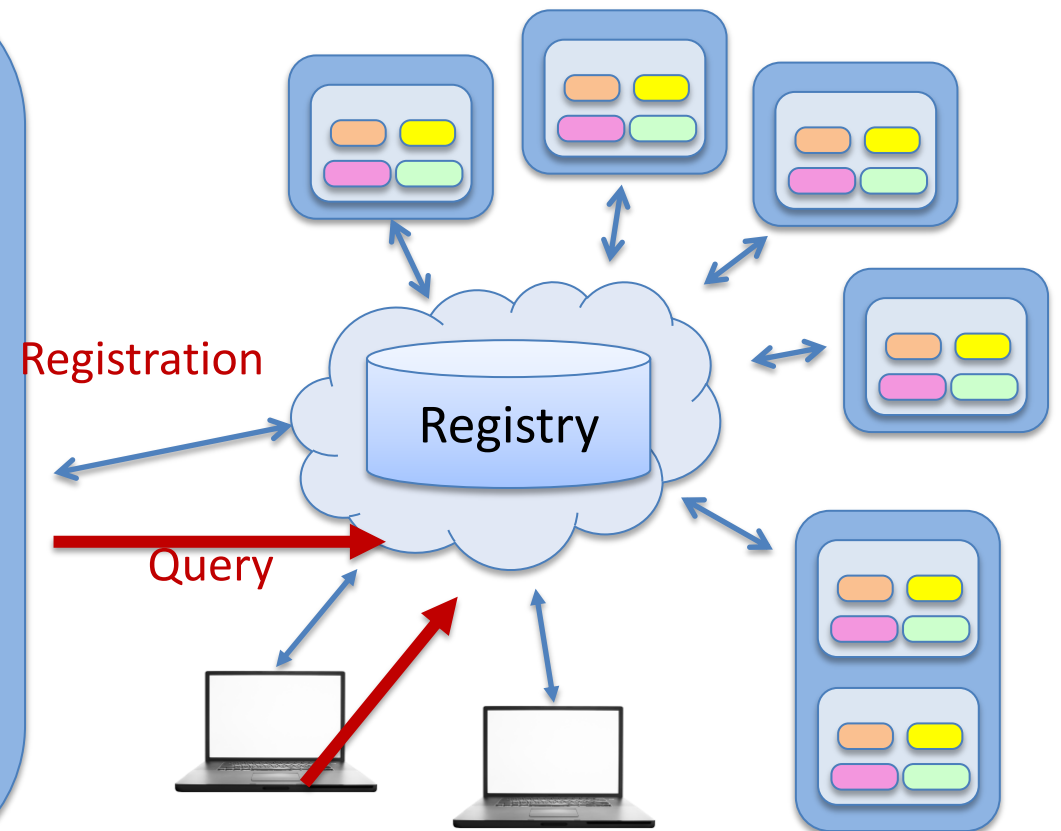
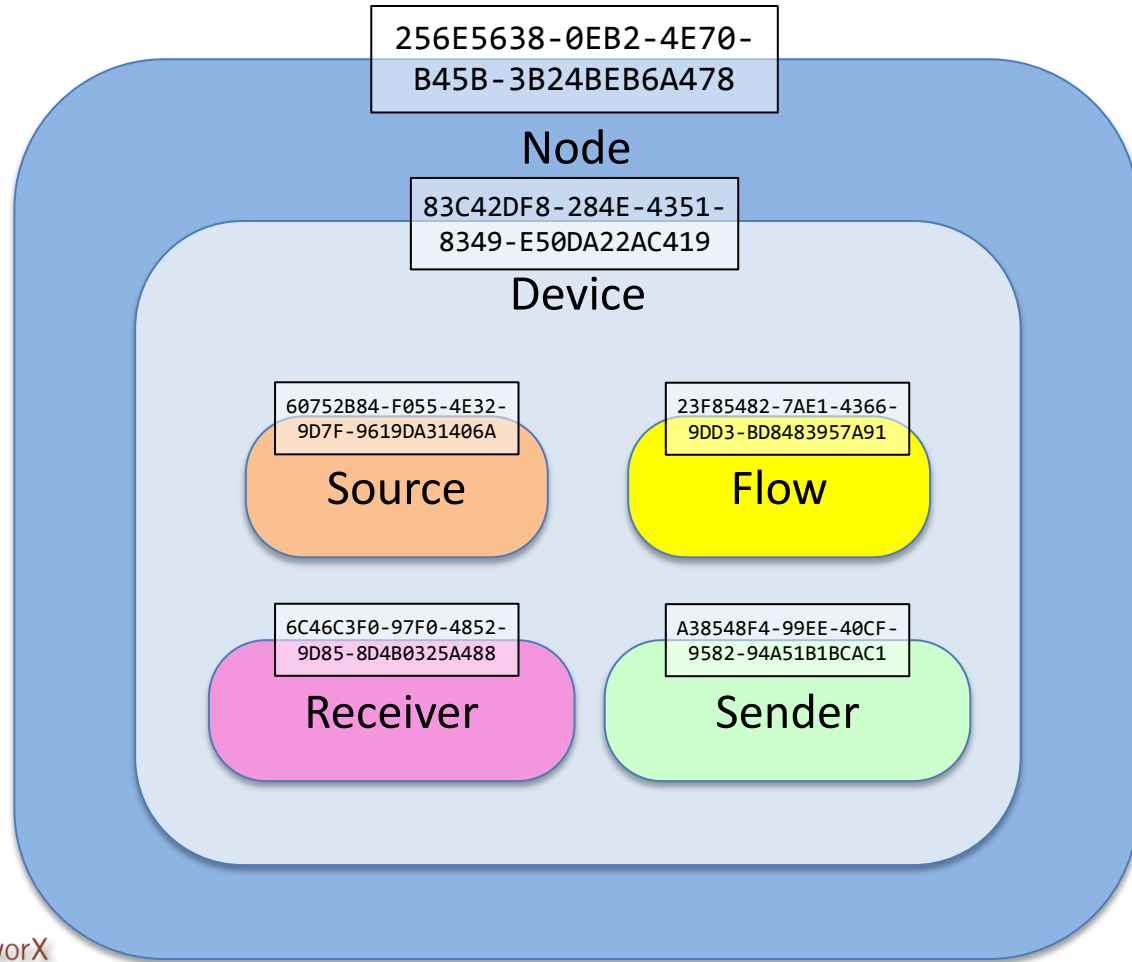

AMWA NMOS - Networked Media Open Specifications

IS-05

Connection Management

Make it simple for applications
to (dis)connect flows

AMWA NMOS - Networked Media Open Specifications

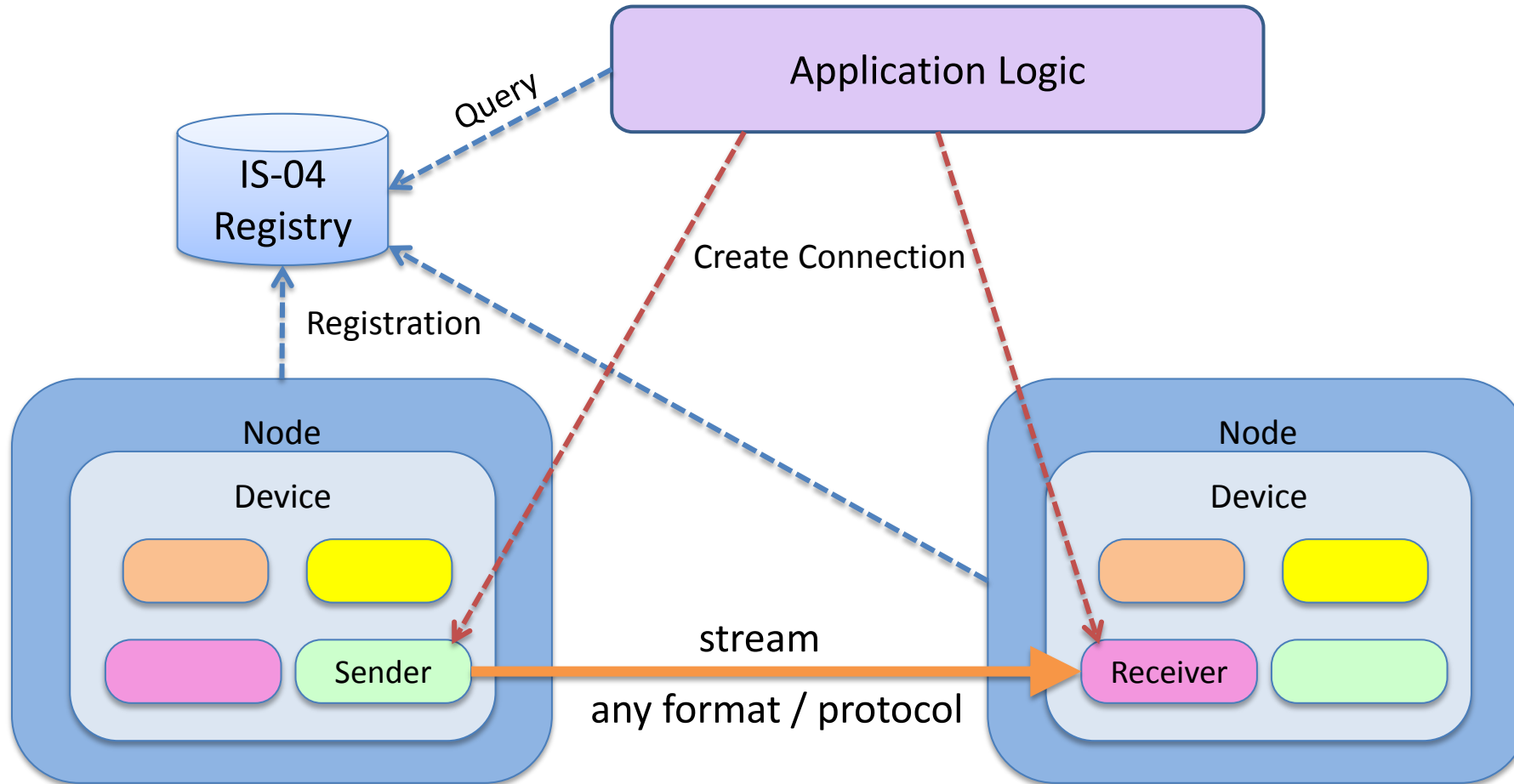

AMWA NMOS - Networked Media Open Specifications

Challenge:



AMWA NMOS - Networked Media Open Specifications

Challenge:

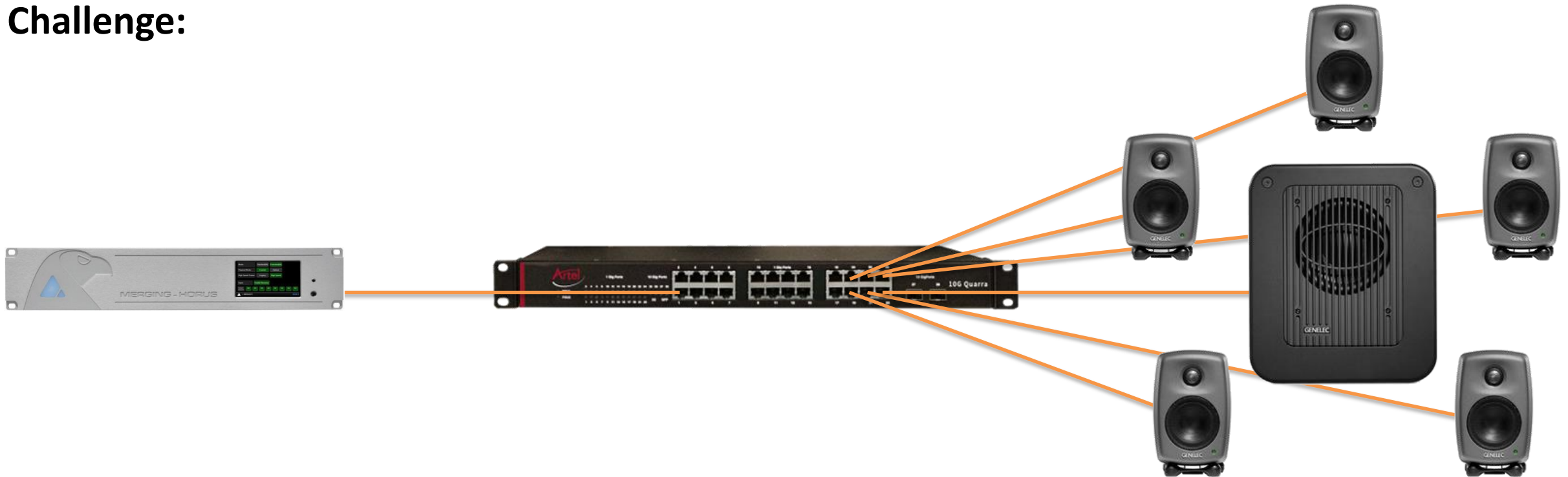

AMWA NMOS - Networked Media Open Specifications

Challenge:

Option 1:

6 unicast streams
with individual channels

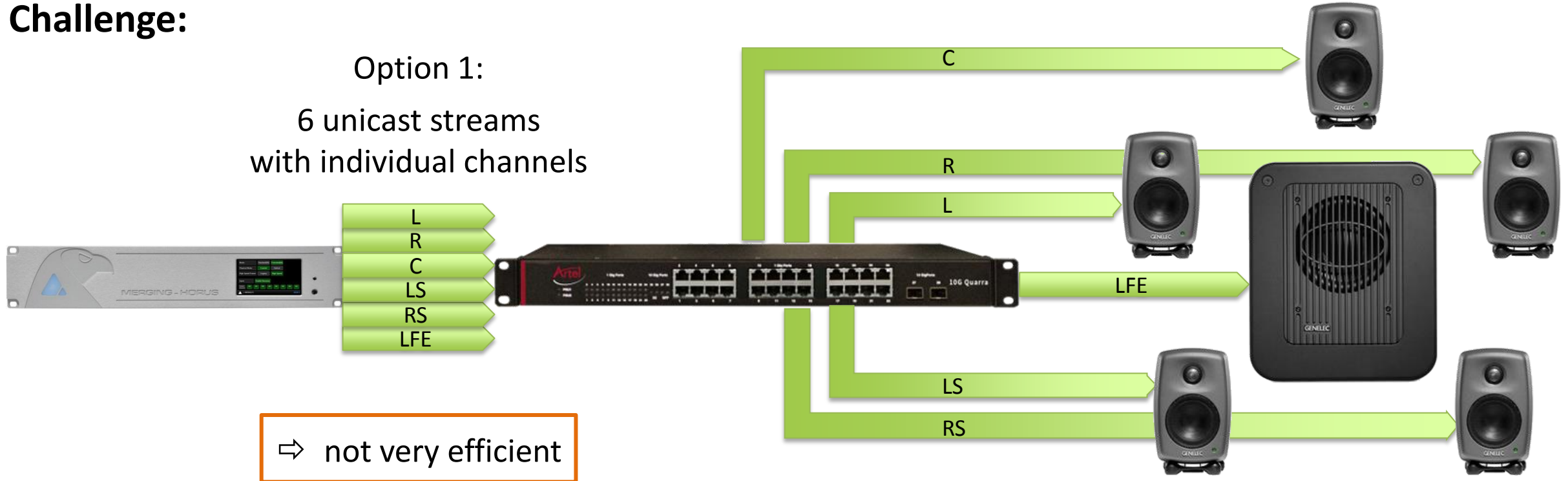

AMWA NMOS - Networked Media Open Specifications

Challenge:

Option 2:
1 multicast stream
w/ all 6 channels

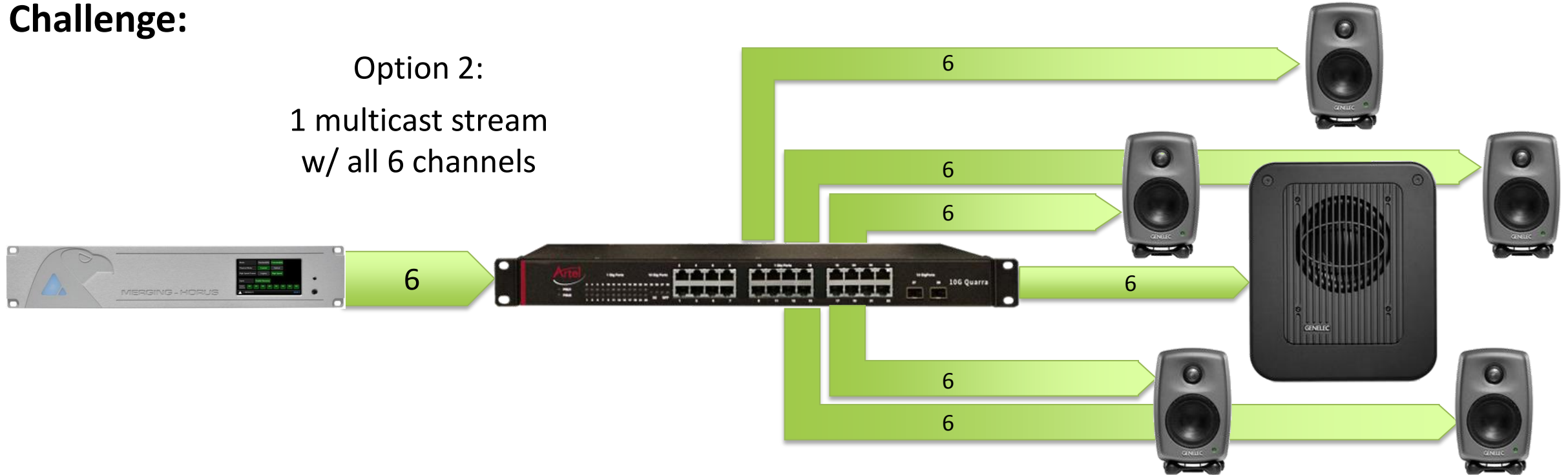

AMWA NMOS - Networked Media Open Specifications

Challenge:

1 multicast stream
w/ all 6 channels



AMWA NMOS - Networked Media Open Specifications

IS-08

Audio Channel Mapping

Map flow channels (tracks) to device I/O channels

AMWA NMOS IS-08 - Audio Channel Mapping

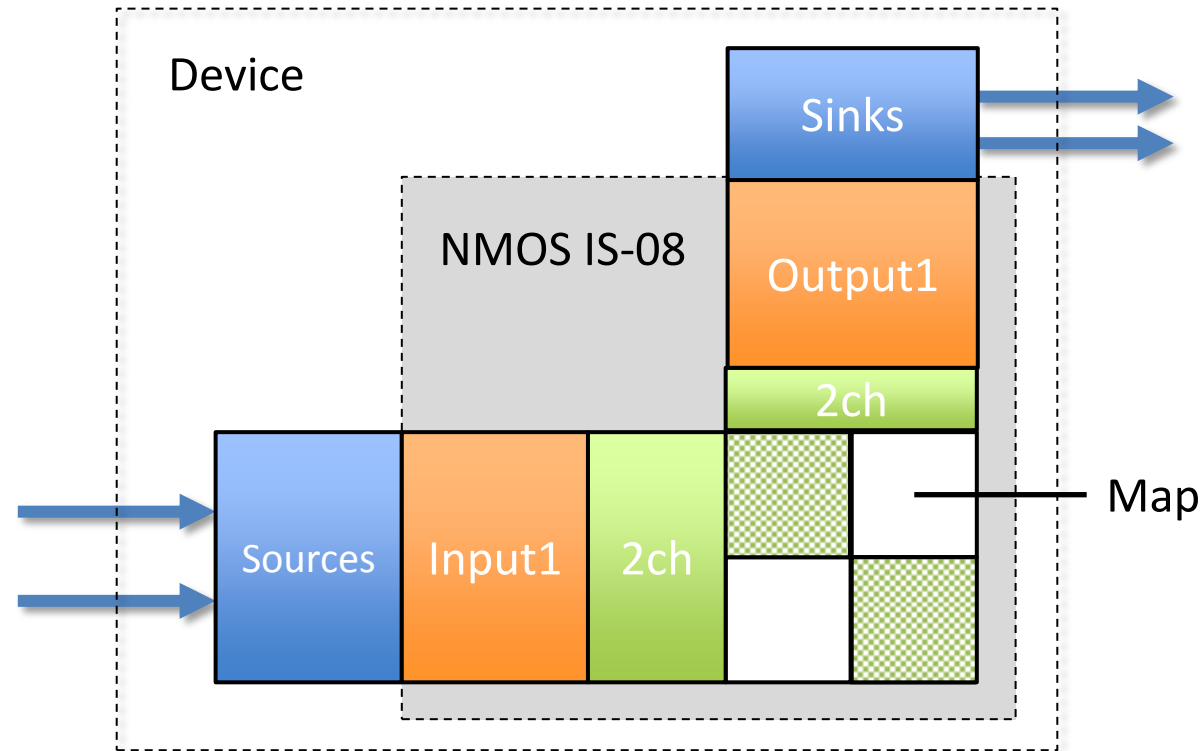

AMWA NMOS IS-08 - Audio Channel Mapping

- Interaction with NMOS IS-05 – connecting incoming stream channels to device output channels

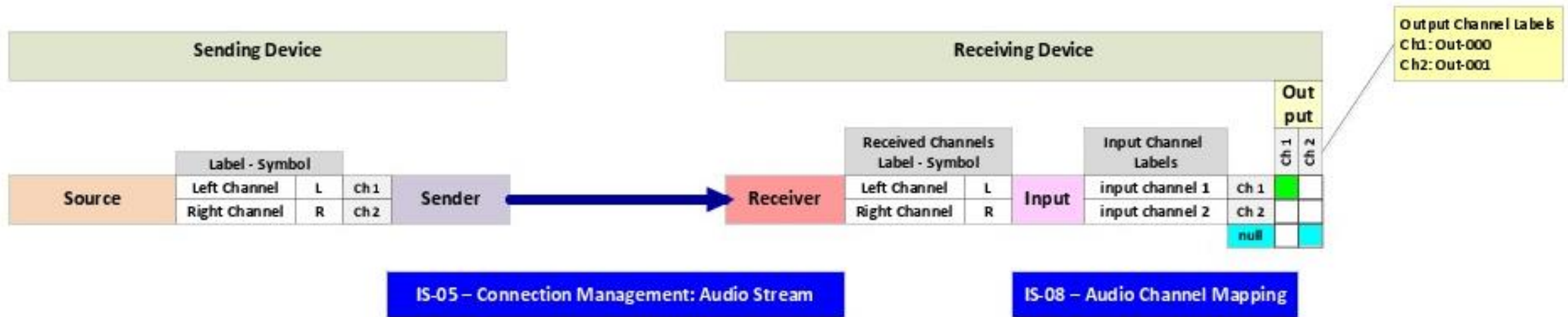

AMWA NMOS IS-08 - Audio Channel Mapping

X-nmos/channelmapping/v1.0/io

```
{
  "inputs": {
    "c200c6d3-e4fa-4170-9f46-d1eeca23173b": {
      "caps": {
        "block_size": 1,
        "reordering": true
      },
      "channels": [
        {
          "label": "input channel 1"
        },
        {
          "label": "input channel 2"
        }
      ],
      "parent": {
        "id": "1153f888-7a09-4783-838b-b00b77d3af85",
        "type": "receiver"
      },
      "properties": {
        "description": "AES67 Audio Input",
        "name": "AES67"
      }
    }
  },
  "outputs": {
    "ee0b65be-ed0c-40b5-affe-9deeb2e383d": {
      "caps": {
        "routable_inputs": [
          "c200c6d3-e4fa-4170-9f46-d1eeca23173b"
        ]
      },
      "channels": [
        {
          "label": "Out-000"
        },
        {
          "label": "Out-001"
        }
      ],
      "properties": {
        "description": "ALSA dmix (2ch)",
        "name": "dmix"
      },
      "source_id": "00000000-0000-0000-0000-000000000000"
    }
  }
}
```

AMWA NMOS IS-08 - Audio Channel Mapping

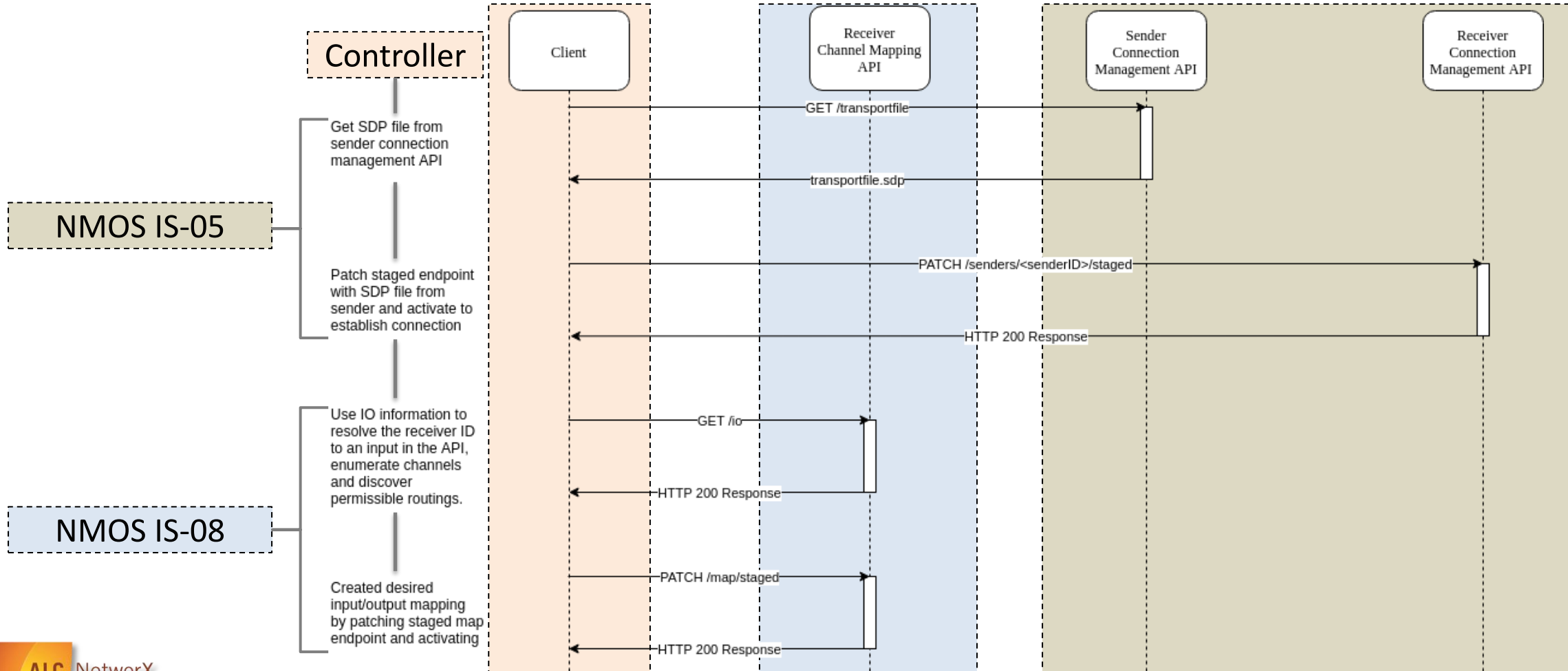

AMWA NMOS IS-08 Audio channel Mapping



IP-SDI Gateway

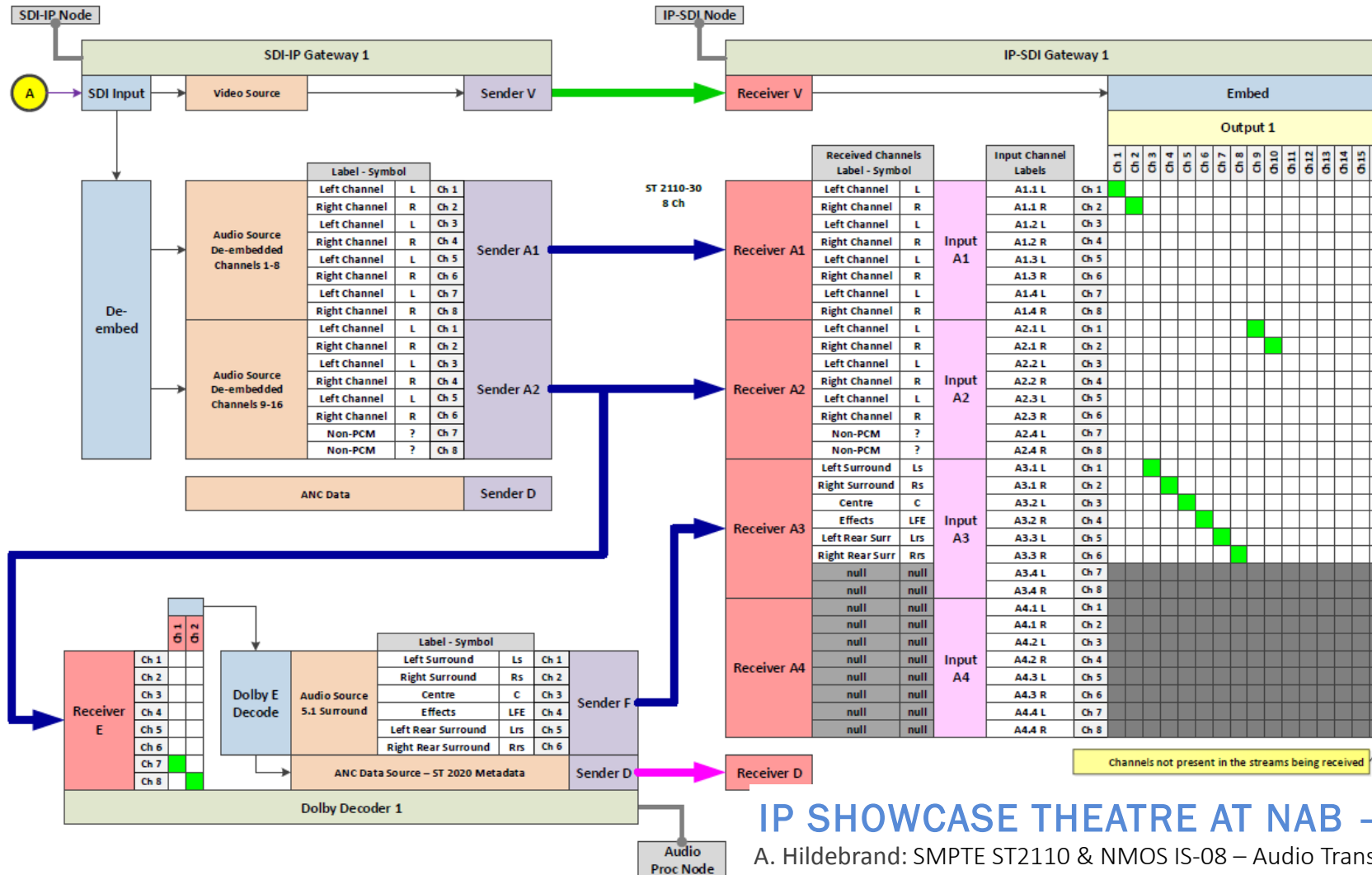

Channels not present in the streams being received

AMWA NMOS - Networked Media Open Specifications

More information on
NMOS wiki on Github:

<https://github.com/AMWA-TV/nmos/wiki>

Thank you for your attention!

**RAVENNA booth North Hall
#N2503**

Contact information:

Andreas Hildebrand
Technology Evangelist
ravenna@alcnetworx.de

ALC NetworX GmbH
Am Loferfeld 58
81249 Munich
Germany



www.ravenna-network.com